

# TraceTek TT3000 and TT5000 Series Bulk Sensing Cable

## General Information

These instructions detail techniques used to install TT3000 or TT5000 bulk sensing cable into double-containment pipe. Installation is made from pull point (access tee) to pull point. Two people, the feeder and the puller, are needed to complete the installation. They must be able to communicate at all times during the installation. Two-way radios may be required. These instructions assume that 1/4-inch or 3/8-inch hollow braid pull rope has been installed according to the *TraceTek Double Containment Installation Guide* (LIT-138). To ensure that the pipe is cable ready, see the *TraceTek Products Selection Guide* (H54783), Section 2. After the cable has been installed, use the connector installation instructions included in connector kits for TT3000 and TT5000 sensing cables (TT-3000-CK-MC-xxx or TT-5000-CK-MC-xxx). For more information call (800) 553-1737.

## Tools and Materials Needed

- Ohmmeter (20 M range or greater)
- Kellems grip (TT-KELLEM-GRIP)
- Reel mounting stand (to allow reel to spin and pay off sensing cable; see page 3)
- Two lengths of 3/4-inch electrical conduit bent to a gentle sweep. These must be longer than the highest riser (the vertical pipe section at access tees), flared slightly, and deburred at both ends (see Step 4 on page 3).
- Electrical tape

*In addition, for installing TT5000 series sensing cables:*

- TT-ULTRATORCH flameless heating tool or appropriate heat gun
- Pliers (to crimp heat-shrinkable tubing)
- Masking tape

## General Notes

### Do

- Store the sensing cable in its original container in a clean, dry area prior to installation.
- Schedule sensing cable installation after pipe is assembled and pressure tested.
- Install alarm module first, then install sensing cable from the module outward.
- Clean the area where the cable will be installed, to remove debris and sources of contamination.
- Install sensing cable before burying pipe.
- Provide "as built" drawings to facilitate completion of a system map.
- Replace TT5000 sensing cable once it has contacted a solvent or fuel.

### Don't

- Drag the cable through contaminants (such as pipe dope, PVC cement, alcohol, oil, dirt).
- Use damaged or contaminated sensing cable.
- Solder or weld near the cable without protecting it from heat, flux, and splatter.
- Use pulling lubricants to install TraceTek cables.
- Drop tools, or sharp or heavy objects onto the cable.
- Pull sensing cable with excessive force (more than 50 pounds /20 kg for TT5000, more than 75 pounds/30 kg for TT3000).
- Pull bulk TT5000 sensing cable without sealing its end.
- Place TT5000 sensing cable where it is subject to pinching or temperatures above 60°C (140°F).
- Leave TT5000 sensing cable installed under tension.
- Use adhesive tapes or clamping devices to permanently secure the sensing cable.
- Allow cable ends to become wet, dirty, or contaminated.

## Sensing Cable Installation in Double-Containment Piping

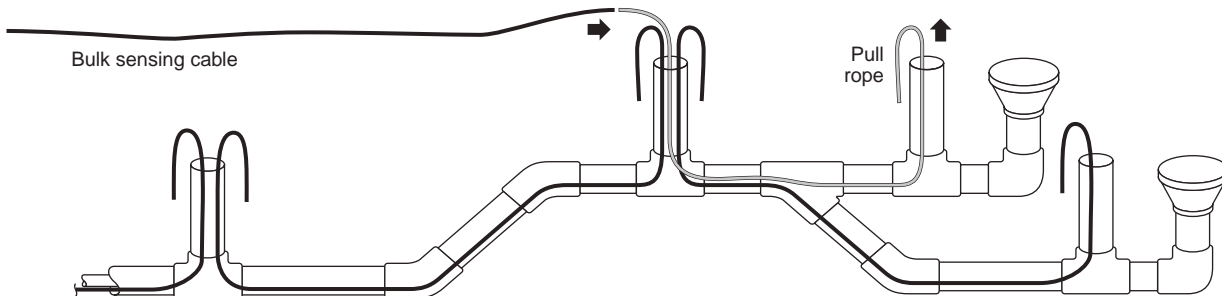

### Check that preinstallation requirements have been met before installing cable in double-containment pipe:

1. The pipe annulus is clean and dry and has been pressure-tested.
2. A continuous length of 1/4-inch to 3/8-inch (6-mm to 9.5-mm) hollow braid polypropylene or nylon rope has been installed from access to access of the containment piping as a pull rope.
3. The pull rope moves freely through the pipe (for example, it is not knotted, pinched, or glued to the pipe).

## Installation Steps

### 1. Prepare the sensing cable prior to installation.

#### For TT5000 sensing cable:

Ensure that the end of the cable is sealed with heat-shrink tubing (as it was when supplied from the factory). If the cable end is **not** sealed:

1. Trim the end of the cable as necessary to remove any irregularities.
2. Apply a single layer of masking tape 3/4 inch (19 mm) from the end of the cable.
3. Push the fluoropolymer braid back and clip it off back to the masking tape (see illustration at right). Take care not to damage the black cable jacket; if jacket is damaged, trim the end off and begin again.
4. Slide one of the heat-shrinkable tubes (catalog no. DWP-125-1/4, supplied with the bulk reel) over the cable and past the masking tape. **Remove the masking tape**, then position the tube so that 3/8 inch (9.5 mm) of the tubing extends beyond the end of the cable.
5. Using a Raychem heat gun or Ultratorch, shrink the tube down to bond to the sensing cable. Begin at the end over the cable braid. Apply heat long enough to fully recover the tubing, but not so long as to melt the braid; do not apply heat directly on the braid, and if braid is damaged, begin again. In the middle of the tube, continue heating for 10 to 15 seconds after the tubing has shrunk, to ensure adhesive in the tubing bonds to the cable jacket. Shrink the entire tube, finishing at the end off the cable.
6. While the tubing end is still hot, use pliers to crimp and seal the end, as shown.
7. Let the tubing and cable end cool a minute or two before proceeding with insertion into the Kellems grip.

**Note:** Drawings are not to scale

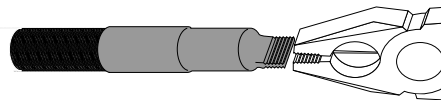
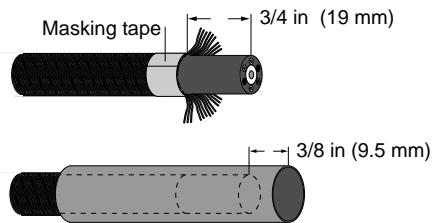

#### For TT3000 sensing cable:

1. Prepare the cable and perform resistance measurement to confirm the cable is clean and dry.
  - Locate and expose the cable end from the inside of the reel (not the end to be pulled).
  - Expose 1 to 2 inches (25 to 50 mm) of the two black wires by prying them out of the cable.
  - Strip 1/2 inch (12 mm) of the black material to expose the copper wire. **Note:** The black material is conductive; it is not insulation.
  - Use an ohmmeter to measure the resistance between the two black wires; attach the ohmmeter leads to the exposed copper. For a clean, dry cable, the resistance should be greater than 20 MΩ.
  - *If the resistance is less than 20 MΩ*, check to see if there is moisture or contamination on the cable. If the problem causing a low-resistance reading cannot be located, the sensing cable may be damaged. Contact Raychem for help.
2. While TT3000 cable is being installed in double-containment pipe, it must be monitored with an ohmmeter to alert the feeder if moisture is encountered. Clip the ohmmeter to the two black wires and tape it to the outside of the cable reel flange (see illustration).
3. Wrap a small amount of electrical tape tightly around cable end to be pulled; this makes it easier to insert in the Kellems grip.

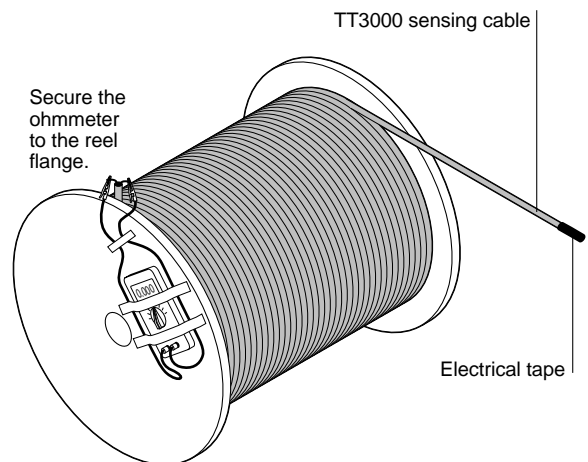
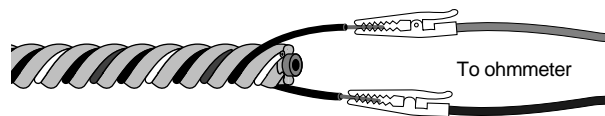

## Installation Steps (continued)

**Note:** Begin cable installation at the end of the pipe closest to the TraceTek alarm and locating module.

### 2. Attach Kellems grip to sensing cable.

1. Make sure the end of the sensing cable has been properly prepared (end of TT5000 sensing cable should be sealed with heat-shrink tubing; end of TT3000 should be wrapped tightly with electrical tape).
2. Insert the end of the cable as far as possible into the cage end of the Kellems grip.
3. Tightly wrap electrical tape over 1 in (25 mm) of the Kellems grip and 1 in (25 mm) of the exposed sensing cable to make a smooth transition.

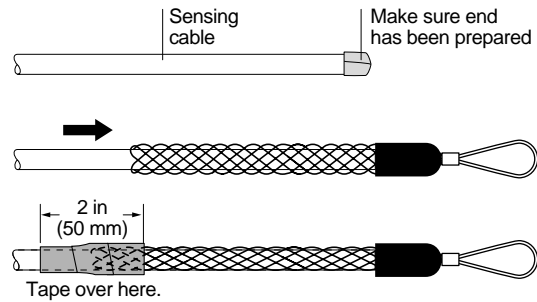

### 3. Attach pull rope to Kellems grip.

1. To ensure the end of the pull rope is compact and has no loose strands, tightly wrap the tip with electrical tape.
2. Feed the end of the pull rope through one of the sections of sweep conduit, curved end first (see illustration).
3. Open the braid 18 in (450 mm) from the end of the pull rope. A pencil or screwdriver can be used.
4. Pass the rope end through the looped end of the Kellems grip and insert 6 in (150 mm) through the braid opening and into the hollow core of the rope. Tightly wrap tape over the end of the rope and back 2 in (50 mm) toward the loop (see illustration).

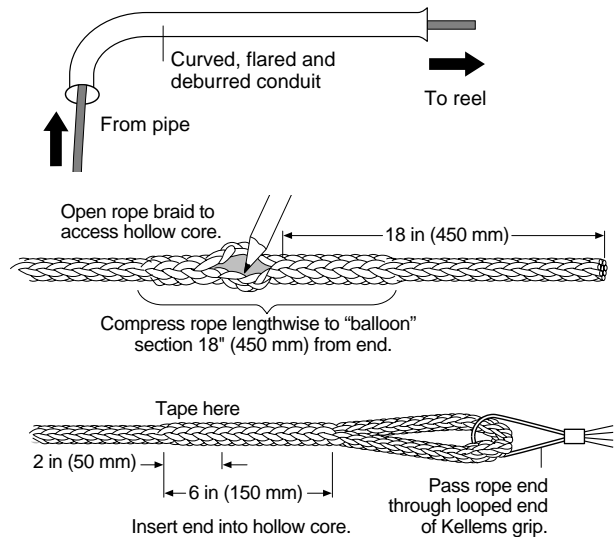

### 4. Prepare to pull sensing cable into pipe.

1. Insert the curved end of the conduit section into the access tee down to the level of the primary pipe. Use the conduit to guide the pull rope and sensing cable into the pipe; position it to avoid sharp bends, abrasion, and snags.

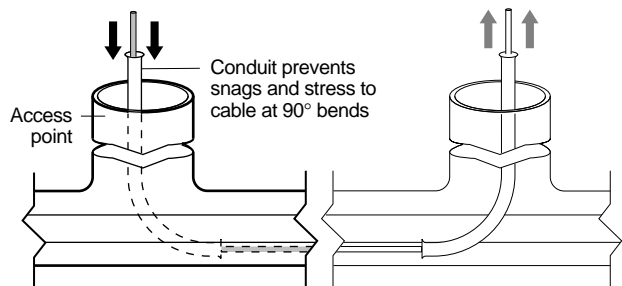

2. Mount the cable reel onto a payoff stand; insert a piece of pipe through the reel flange holes and support it with two chairs or some other appropriate means (see illustration). The reel must be free to turn.

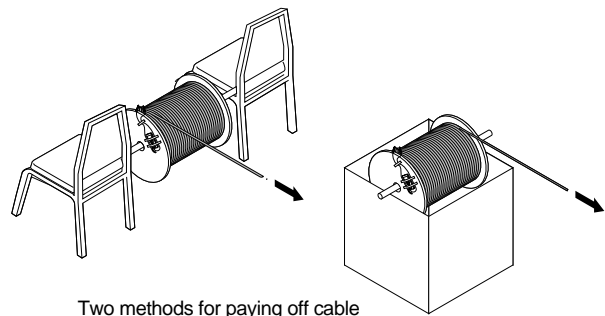

## Installation Steps (continued)

### 4. Prepare to pull sensing cable into pipe (continued).

#### 3. Prepare to Pull from Next Access Point

- Take the second piece of sweep conduit to the next access point of the containment pipe.
- Identify the correct pull rope. If there is more than one section of pull rope at this access point, the person to feed cable can lightly tug the rope from the sensing cable end to identify the correct rope.

**Important: Be careful not to lose the rope into the access point.** It can be time-consuming and expensive to recover a pull rope lost into the pipe.

If the pull rope has been installed as one continuous length (that is, looped but not cut at each access tee), it must be cut at the access tee.

**Important:** After cutting, secure the end not attached to the sensing cable.

- At the access point, pass the installed pull rope through the conduit, curved end first.
- Insert the curved end of the conduit into the access tee down to the level of the primary pipe. Use the conduit section to guide the pull rope and sensing cable out of the pipe; position it to avoid sharp bends, abrasion, and snags.

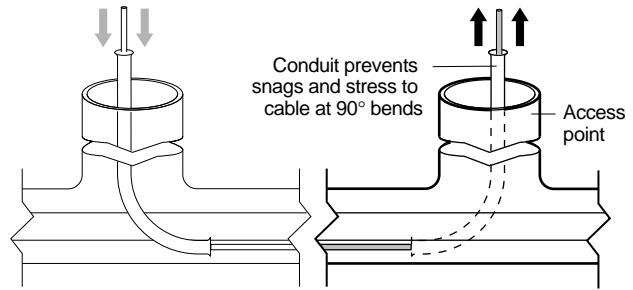

### 5. Pull sensing cable into containment pipe.

1. Hold the conduit in position while pulling the cable. Begin to pull the rope and cable from the second access point. The person feeding the cable must be able to communicate problems (such as snags or twisted cable) to the person pulling, before the sensing cable is subjected to excessive stress.

**TT5000 sensing cable must not be pulled with force greater than 50 pounds** or the cable may be damaged.

When installing TT3000 sensing cable, use the ohmmeter on the payoff reel to monitor the cable condition during pulling. If the ohmmeter measures a resistance less than 20 M $\Omega$  between the sensing wires, it indicates the sensing cable has encountered water or contaminant. **If this happens, stop pulling at once.** Carefully remove the sensing cable; maintain a light tension on the pull rope as the cable is pulled out, because the Kellems grip is not designed for tension in this direction. Dry or clean pipe before reinstalling sensing cable. Be sure to secure the ends of the pull rope.

2. Finish by pulling the cable through the conduit beyond the top of the access point riser. Leave at least 12 in (30 mm) of extra cable for installation of connectors.

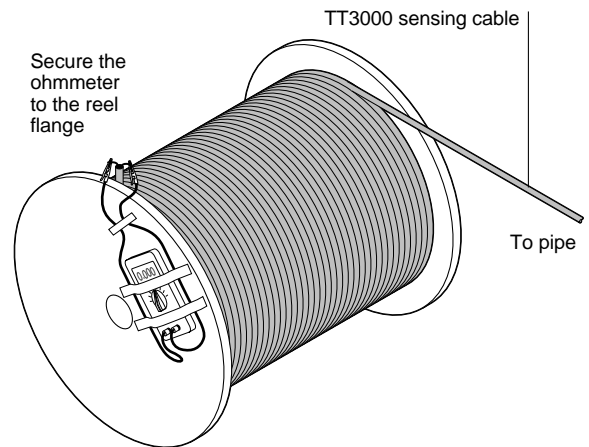

### 6. Check the sensing cable condition.

**Important:** TT5000 sensing cable is sensitive to pressure from such things as pinches or tight corners. After pulling, make sure the cable has adequate clearance and is not left under tension.

For TT3000 sensing cable, use the ohmmeter on the payoff reel to confirm that the cable is clean and dry. If the ohmmeter measures a resistance of less than 20 M $\Omega$  between the sensing wires, corrective action will be required.

If TT5000 sensing cable has been installed, first prepare the cable for testing.

- Remove the Kellems grip, and then cut off and discard the section of cable that was in the Kellems grip.
- Slit and remove 3/4 in (19 mm) of outer braid and black jacket.
- Unbraid the two black wires, and strip 1/2 in (12 mm) of the black material to expose their copper wire.

## Installation Steps (continued)

### 6. Check the sensing cable condition (continued).

- Slit an additional 1/2 in (12 mm) of outer braid and black jacket. Flare the jacket so that it does not touch either black wire (see illustration).

Use an ohmmeter to check that the cable has not been damaged or left in an alarm condition.

- Measure the resistance between each black wire and the black (conductive) jacket.
- Measure the resistance between the two black wires.

In all cases the resistance should be greater than 20 MΩ. *If the measured resistance is less than 20 MΩ:*

- Confirm that the black wires at either end of the cable are not touching the black jacket. If they touch the jacket, move them away from the jacket and retest.
- Confirm that the cable is not pinched by the reel flange or other object. If the cable is pinched, correct the problem and retest.
- If the measured resistance is still below 20 MΩ, it may indicate the cable is bent or crimped (which simulates a leak), or the cable has been tripped by exposure to a hydrocarbon (such as oil or adhesive), or the jacket has been damaged and allowed water to enter the braided inner construction. A TraceTek Portable Test Box (TT-PTB-1000) may be used to determine the location of the problem; contact your Raychem representative for further information. In any case, determine the cause of the problem and address it.

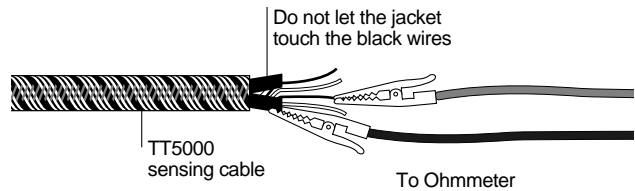

### 7. Complete the installation process.

If the results of the cable test are satisfactory and the sensing cable will be left in the pipe:

- Remove the conduit sections used to guide the cable during installation. Before cutting the cable at the feeder end, make sure that at least 12 in (300 mm) of sensing cable (not including the Kellems grip) is above each riser to allow for connector installation.
- Cut off and discard the section of cable that was in the Kellems grip. (**Note:** For TT5000 cable, this should have been done in the previous step, when preparing for cable testing).
- If possible, install connectors on ends of sensing cable immediately after pulling, following instructions supplied with the connector kits.

**Important: Water must not be permitted to enter the end of TT5000 cable.** If not installing connectors on TT5000 cable, be sure to seal the end with heat-shrinkable tubing, as described in Step 1 on page 2.

- For connectors not mated to another sensing cable, attach an end termination to prevent water ingress.
- Secure the end of cable so it is not lost into the pipe.

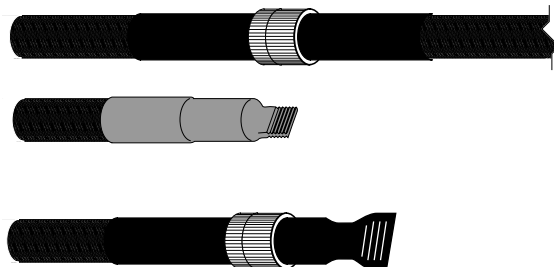

At the end of the day or if the job is interrupted by bad weather, seal all access points to keep moisture and contaminants out of the pipe.

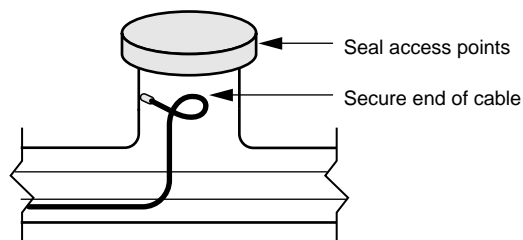

*Tyco Thermal Controls, LLC*  
**Commercial & Industrial  
Infrastructure Division**

**300 Constitution Drive  
Menlo Park, CA 94025-1164**

**REPRESENTED BY:**

*Industrial Heater*  
**8400 Wolf Lake Dr.  
Suite #101  
Bartlett, TN 38133  
TEL: (888) 451-4328  
FAX: (901) 382-4766**